



## Table of Contents

<b>Chapter 1 - Introduction</b> .....	<b>1</b>
1.1 Copyright Notice.....	2
1.2 About User's Manual .....	2
1.3 Warning.....	2
1.4 Replacing the lithium battery .....	3
1.5 Technical Support .....	3
1.6 Warranty.....	4
1.7 Packing List .....	5
1.8 Ordering Information .....	5
1.9 Specification .....	6
1.10 Board Dimensions.....	7
<b>Chapter 2 - Installation</b> .....	<b>9</b>
2.1 Block Diagrams.....	10
2.2 Jumpers and Connectors .....	11
KBM1: Keyboard & Mouse Connector .....	13
LAN1: Fast Ethernet Connector.....	13
IDE1: 44 pin IDE Connector.....	14
PWR1: Power Supply Connector.....	14
PC/104: PC/104 ISA Interface .....	15
JRS1: COM 2 RS-232/422/485 Select.....	16
LLED1: LAN LED Indicators.....	16
JFRT1: Switches and Indicators.....	16
IR1: Infrared Connector .....	17
VGA1: CRT Connector.....	17
USB1: USB Connector.....	17
FDD1: 20 pins FDD Connector .....	18
JBAT1: CMOS Setup .....	18
LPT1: 20 pins Parallel Port Connector.....	19
CON1: RS-422/ 485 Output Connector .....	19
LCD1: TTL LCD Connector.....	20

---

COM1/ COM2: Serial Port Connector .....	20
CFD1: CompactFlash II Socket .....	21
2.3 The Installation Paths of CD Driver .....	22
<b>Chapter 3 - BIOS .....</b>	<b>23</b>
3.1 BIOS Introduction.....	24
3.2 BIOS Setup.....	24
3.3 Standard CMOS Features .....	25
3.4 Advanced BIOS Features.....	28
3.5 Advanced Chipset Features .....	30
3.6 Integrated Peripherals .....	32
3.7 PNP/PCI Configurations.....	39
3.8 PC Health Status.....	41
3.9 Load Optimized Defaults .....	42
3.10 Set Password .....	43
3.11 Save & Exit Setup .....	44
3.12 Exit Without Saving .....	45
3.13 BIOS Beep Sound code list.....	46
3.14 BIOS memory mapping.....	46
3.15 Award BIOS POST Codes .....	47
<b>Chapter 4 - Appendix .....</b>	<b>51</b>
4.1 I/O Port Address Map.....	52
4.2 Interrupt Request Lines (IRQ).....	53
4.3 DMA Map.....	53
4.4 Memory Address Map.....	54

# Chapter 1

## Introduction

## **1.1 Copyright Notice**

All Rights Reserved.

The information in this document is subject to change without prior notice in order to improve the reliability, design and function. It does not represent a commitment on the part of the manufacturer.

Under no circumstances will the manufacturer be liable for any direct, indirect, special, incidental, or consequential damages arising from the use or inability to use the product or documentation, even if advised of the possibility of such damages.

This document contains proprietary information protected by copyright.

All rights are reserved. No part of this manual may be reproduced by any mechanical, electronic, or other means in any form without prior written permission of the manufacturer.

## **1.2 About User's Manual**

This User's Manual is intended for experienced users and integrators with hardware knowledge of personal computers. If you are not sure about any description in this User's Manual, please consult your vendor before further handling.

## **1.3 Warning**

Single Board Computers and their components contain very delicate Integrated Circuits (IC). To protect the Single Board Computer and its components against damage from static electricity, you should always follow the following precautions when handling it :

1. Disconnect your Single Board Computer from the power source when you want to work on the inside.
2. Hold the board by the edges and try not to touch the IC chips, leads or circuitry.
3. Use a grounded wrist strap when handling computer components.
4. Place components on a grounded antistatic pad or on the bag that came with the Single Board Computer, whenever components are separated from the system.

## **1.4 Replacing the lithium battery**

Incorrect replacement of the lithium battery may lead to a risk of explosion. The lithium battery must be replaced with an identical battery or a battery type recommended by the manufacturer.

Do not throw lithium batteries into the trashcan. It must be disposed of in accordance with local regulations concerning special waste.

## **1.5 Technical Support**

Please do not hesitate to e-mail our support team when you need assistance.  
[www.diamondsystems.com](http://www.diamondsystems.com)  
[support@diamondsystems.com](mailto:support@diamondsystems.com)

## **1.6 Warranty**

This product is warranted to be in good working order for a period of two years from the date of purchase. Should this product fail to be in good working order at any time during this period, we will, at our option, replace or repair it at no additional charge except as set forth in the following terms. This warranty does not apply to products damaged by misuse, modifications, accident or disaster.

Vendor assumes no liability for any damages, lost profits, lost savings or any other incidental or consequential damage resulting from the use, misuse of, or inability to use this product. Vendor will not be liable for any claim made by any other related party.

Vendors disclaim all other warranties, either expressed or implied, including but not limited to implied warranties of merchantability and fitness for a particular purpose, with respect to the hardware, the accompanying product's manual(s) and written materials, and any accompanying hardware. This limited warranty gives you specific legal rights.

Return authorization must be obtained from the vendor before returned merchandise will be accepted. Authorization can be obtained by calling or faxing the vendor and requesting a Return Merchandise Authorization (RMA) number. Returned goods should always be accompanied by a clear problem description.

## 1.7 Packing List



1 x Rhodeus-LC



1 x CD-ROM



1 x Quick Installation Guide

If any of the above items is damaged or missing, contact your vendor immediately.

## 1.8 Ordering Information

Rhodeus-LC	PC/104 CPU module with AMD Geode™ LX800 (500MHz), 1 x SO-DIMM, CRT/LCD & LAN
Cable Kit (Optional)	1 x USB Cable 2 x COM Port Cable 1 x FDD Flat Cable 1 x IDE Cable 1 x Parallel Port Cable 1 x LAN Cable 1 x VGA Cable 1 x KB/MS Cable

## 1.9 Specification

Form Factor	PC/104 CPU module
Processor	AMD Geode™ LX800
Cache	64K L1 cache and 128K L2 cache
Chipset	AMD LX800 + CS5536
System Memory	1 x 200 pins DDR SO-DIMM up to 1GB SDRAM
VGA/ LCD Controller	AMD Geode LX series CPU integrated VGA controller with 2D Engine (Shared memory Max. 64MB)
Ethernet	Realtek 8100CL 10/100 base-T Ethernet
LCD	Supports 18/24-bit TTL up to 1280 x 1024
I/O Chips	W83627HG
BIOS	Phoenix-Award BIOS
IDE Interface	1 x Ultra DMA 33, support 2 IDE devices
Serial Port	2 x RS-232 ports COM2: RS-232/RS-422/RS-485 selectable
Parallel Port / Floppy	1 x SPP/EPP/ECP mode 1 x Floppy connector
KBMS	Standard PS/2 Keyboard and Mouse
Universal Serial Bus	2 x USB 2.0 ports
PCI to ISA bridge	ITE8888G
Expansion Bus	1 x PC/104 interface
Flash Disk	1 x Type II Compact Flash Disk Socket up to 4GB
Hardware Monitor	Integrated in W83627HG
RTC	AMD Geode CS5536 built-in RTC with lithium battery
Power Input Connector	1*4 pins power connector
Operation Temp.	-20 - +70°C
Watchdog Timer	1 - 255 Level (Sec. or Min.)
Dimension (L x W)	96 x 90 mm (3.8" x 3.5")

## 1.10 Board Dimensions

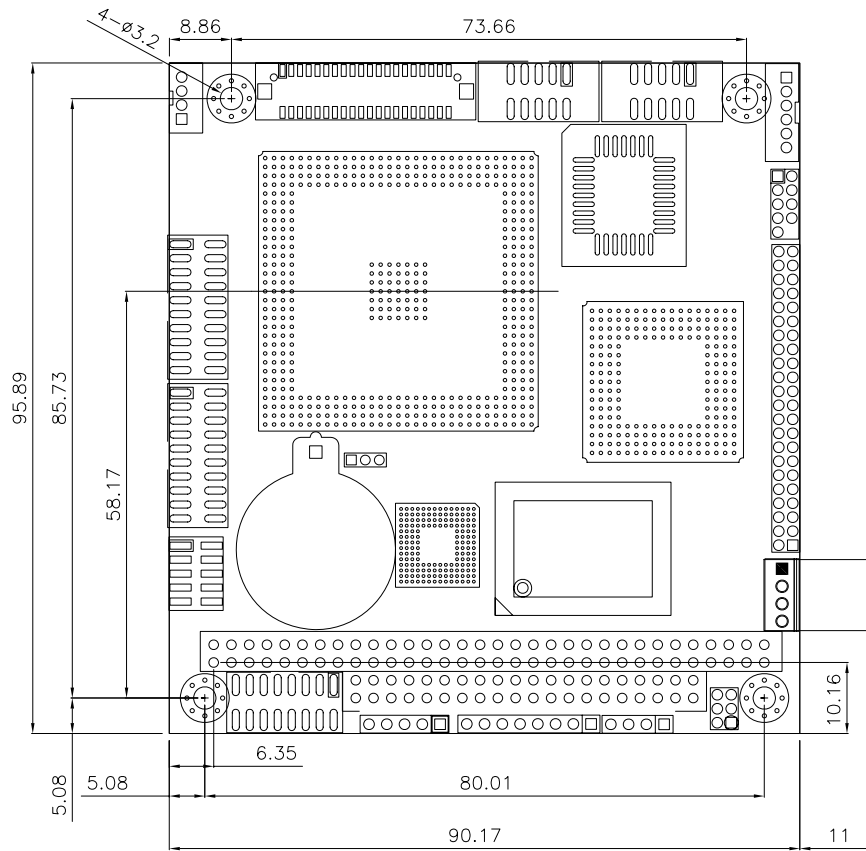

Unit:mm

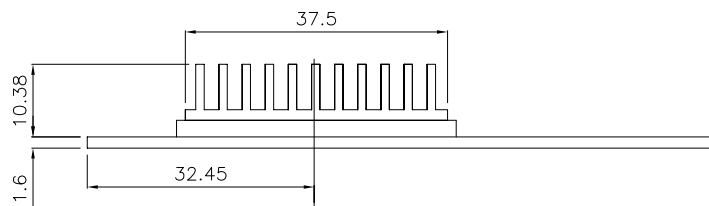

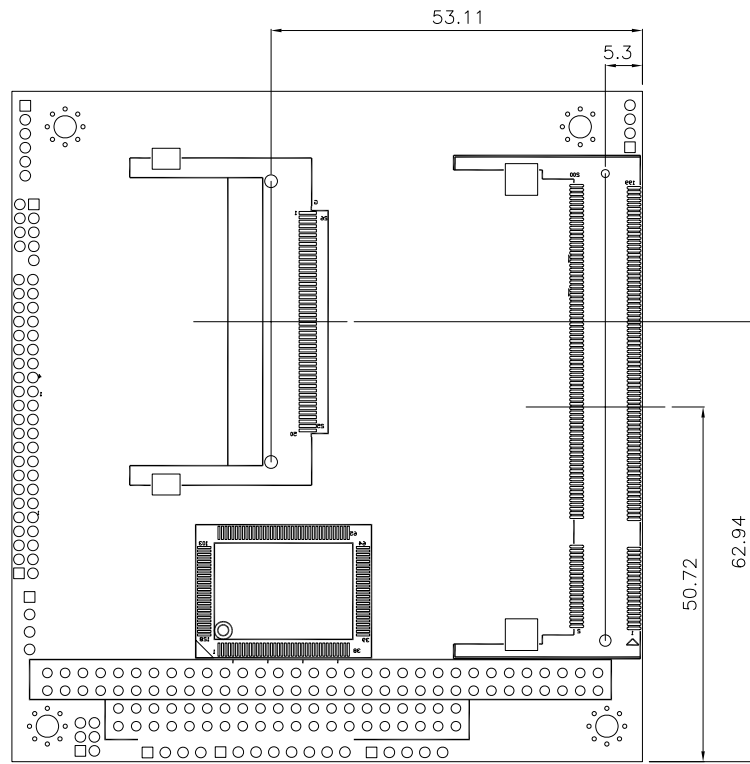

Unit:mm

# Chapter 2

# Installation

## 2.1 Block Diagrams

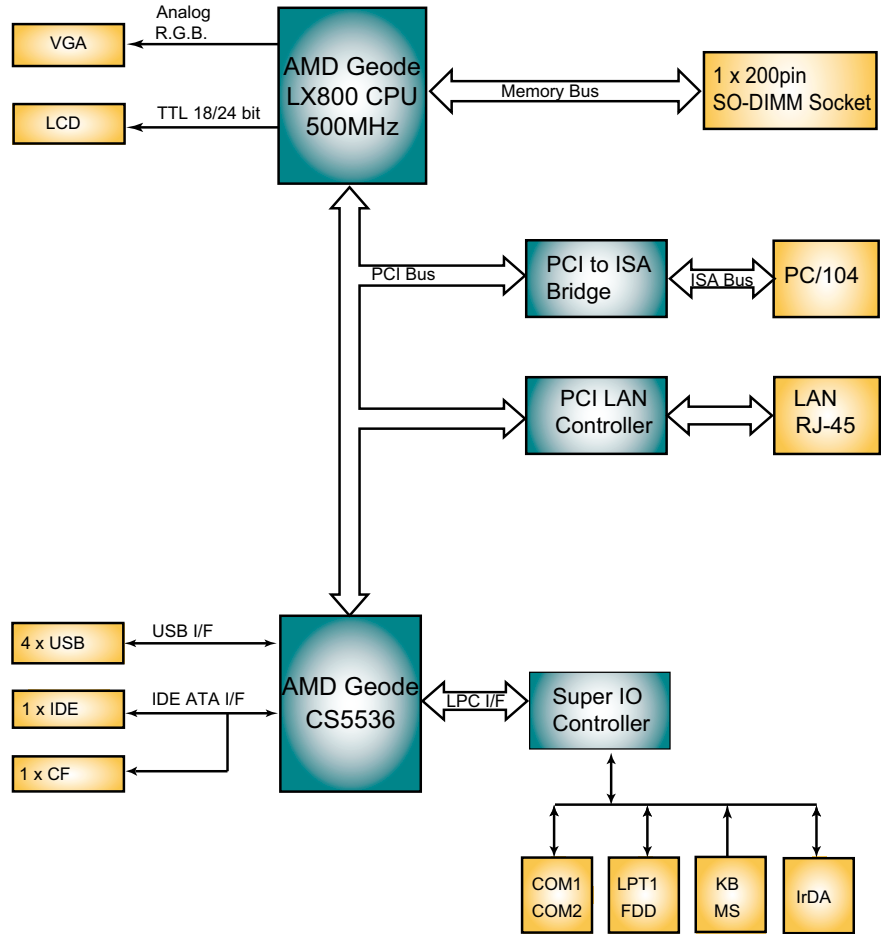

## 2.2 Jumpers and Connectors

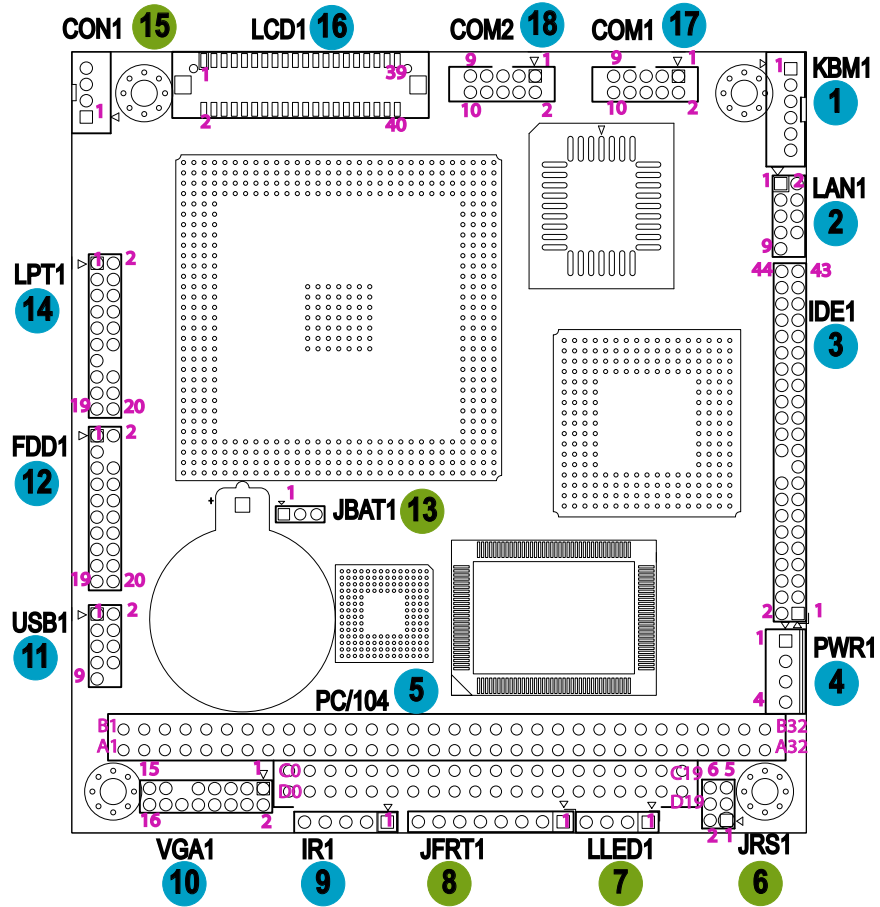

---

## Jumper / Connector Quick Reference

### Jumpers

Label	Function
JRS1	COM2 RS-232/422/485 Select
JBAT1	CMOS Jumper Settings

### Connectors

DIMM1	200 pins DDR SDRAM DIMM Socket
PC104_1	PC/104 for ISA Interface
KBM1	PS/2 Keyboard and Mouse
VGA1	CRT Display
LCD1	TTL LCD Panel Connector
COM1 ~ COM2	Serial Ports
CON1	RS-422/485 Output
IR1	Infrared (IR) Connector
LPT1	Parallel Port
LAN1	LAN Ethernet Connector
LLED1	LAN LED Connector
USB1	USB 1/2 Connector
PWR1	Power Connector Small 4P
JFRT1	Front Panel (Switches and Indicators)
FDD1	Floppy Disk Drive Connector
IDE1	Primary IDE Connector
CFD1	Compact Flash Socket

## Installation

---

### **KBM1: Keyboard & Mouse Connector (1)**

Connector type: 2.0mm pitch 1x6 pins wafer connector

Pin	Description
1	KB_DATA
2	GND
3	MS_DATA
4	KB_CLK
5	KB_VCC
6	MS_CLK

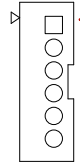

### **LAN1: Fast Ethernet Connector (2)**

Pin	Description	Pin	Description
1	TX+	2	TX-
3	RX+	4	N/C
5	N/C	6	RX-
7	N/C	8	N/C
9	GND	10	N/C (Key)

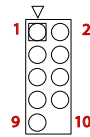

Connector type: 2.0mm pitch 2x5 pin header

**IDE1: 44 pins IDE Connector (3)**

Connector type: 2.0mm pitch 2x22 pin header

Pin	Description	Pin	Description
1	IDE RESET	2	GND
3	DATA7	4	DATA8
5	DATA6	6	DATA9
7	DATA5	8	DATA10
9	DATA4	10	DATA11
11	DATA3	12	DATA12
13	DATA2	14	DATA13
15	DATA1	16	DATA14
17	DATA0	18	DATA15
19	GND	20	N/C (Key)
21	REQ	22	GND
23	IO WRITE	24	GND
25	IO READ	26	GND
27	IO READY	28	IDESEL
29	DACK	30	GND
31	IRQ14	32	N/C
33	ADDR1	34	DIAG
35	ADDR0	36	ADDR2
37	CS#2	38	CS#3
39	IDEACTP	40	GND
41	+5V	42	+5V
43	GND	44	N/C

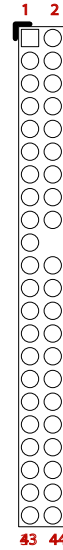

**PWR1: Power Supply Connector (4)**

Pin	Description
1	+5V
2	GND
3	GND
4	+12V

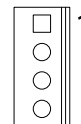

Connector type: 2.54mm pitch 1x4 pins wafer one wall connector

## Installation

### PC/104: PC/104 ISA Interface (5)

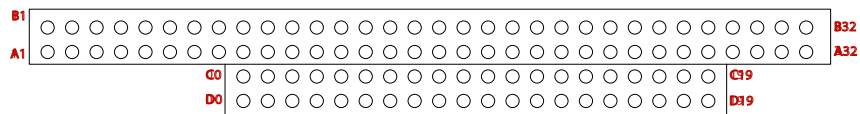



Pin	Description	Pin	Description	Pin	Description	Pin	Description
D0	GND	C0	GND	A1	IOCHCK#	B1	GND
D1	MEMCS16#	C1	SBHE#	A2	SD7	B2	RST_DRV
D2	IOCS16#	C2	LA23	A3	SD6	B3	+5V
D3	IRQ10	C3	LA22	A4	SD5	B4	IRQ9
D4	IRQ11	C4	LA21	A5	SD4	B5	N/C
D5	IRQ12	C5	LA20	A6	SD3	B6	DREQ2
D6	IRQ15	C6	SA19	A7	SD2	B7	N/C
D7	IRQ14	C7	SA18	A8	SD1	B8	0WS#
D8	DACK0#	C8	SA17	A9	SD0	B9	+12V
D9	DREQ0	C9	MEMR#	A10	IOCHRDY	B10	GND
D10	DACK5#	C10	MEMW#	A11	AEN	B11	SMEMW#
D11	DREQ5	C11	SD8	A12	SA19	B12	SMEMR#
D12	DACK6#	C12	SD9	A13	SA18	B13	IOW#
D13	DREQ6	C13	SD10	A14	SA17	B14	IOR#
D14	DACK7#	C14	SD11	A15	SA16	B15	DACK3#
D15	DREQ7	C15	SD12	A16	SA15	B16	DREQ3
D16	+5V	C16	SD13	A17	SA14	B17	DACK1#
D17	MASTER#	C17	SD14	A18	SA13	B18	DREQ1
D18	GND	C18	SD15	A19	SA12	B19	REFRESH#
D19	GND	C19	GND	A20	SA11	B20	SYSCLK
				A21	SA10	B21	IRQ7
				A22	SA9	B22	IRQ6
				A23	SA8	B23	IRQ5
				A24	SA7	B24	IRQ4
				A25	SA6	B25	IRQ3
				A26	SA5	B26	DACK2#
				A27	SA4	B27	TC
				A28	SA3	B28	BALE
				A29	SA2	B29	+5V
				A30	SA1	B30	ISA_CLK
				A31	SA0	B31	GND
				A32	GND	B32	GND

Connector type: PC104 PRESS FIT 2x20P connector

### JRS1: COM 2 RS-232/422/485 Select (6)

It can be configured COM 2 to operate in RS-232, RS-422 or RS-485 mode  
Connector type: 2.00mm pitch 2x3 pin header.

Select	1-2	3-4	5-6
RS-232 (Default)	ON	OFF	OFF
RS-422	OFF	ON	OFF
RS-485	OFF	OFF	ON

### LLED1: LAN LED indicators (7)

Connector type: 2.54mm pitch 1x4 pin header.

Pin	Description
1	LAN1_ACTIVE-
2	LAN1_ACTIVE+
3	LAN1_LINK-
4	LAN1_LINK+

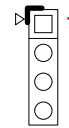

### JFRT1: Switches and Indicators (8)

It provides connectors for system indicators that provides light indication of the computer activities and switches to change the computer status.  
Connector type: 2.54mm pitch 1x8 pin header.

Pin	Description
1	RESET+
2	RESET-
3	PWRLED+
4	PWRLED-
5	HDD LED+
6	HDD LED-
7	SPK OUT+
8	SPK OUT-

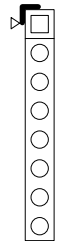

## Installation

### IR1: Infrared Connector (9)

Connector Type: 2.54mm pitch 5 pins header

Pin	Voltage
1	+5V
2	N/C
3	IRRX
4	GND
5	IRTX

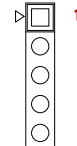

### VGA1: CRT Connector (10)

Connector type: 2.0mm pitch 2x5 pin header

Pin	Description	Pin	Description
1	RED	2	GREEN
3	BLUE	4	N/C
5	GND	6	GND
7	GND	8	GND
9	N/C	10	GND
11	N/C (Key)	12	VDDAT
13	HSYNC	14	VSYNC
15	VDCLK	16	N/C

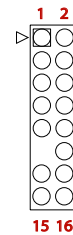

### USB1: USB Connector (11)

USB1 supports two USB 2.0 w/ 480MB/s by pin header

Pin	Description	Pin	Description
1	+5V	2	+5V
3	USB D-	4	USB D-
5	USB D+	6	USB D+
7	GND	8	GND
9	GND	10	N/C (Key)

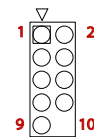

Connector type: 2.0mm pitch 2x5 pin header

### FDD1: 20 pins FDD Connector (12)

Connector type: 2.0mm pitch 2x10 pin header

Pin	Description	Pin	Description
1	GND	2	Drive density Select 0
3	GND	4	N/C (Key)
5	GND	6	Drive Density Select 1
7	Write Data#	8	Index#
9	Write Gate#	10	Motor Enable A#
11	Track 0#	12	Driver Select B#
13	Write Protect#	14	Driver Select A#
15	Read Data#	16	Motor Enable B#
17	Head Select#	18	Direction#
19	Disk Change#	20	Step#

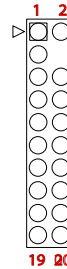

### JBAT1: CMOS Setup (13)

Connector type: 2.0 mm pitch 1x3 pin header.

Pin	Mode	
1-2	Keep CMOS (Default)	
2-3	Clear CMOS	

Note: After Clear CMOS, please make sure to load default in BIOS immediately.

## Installation

### LPT1: 20 pins Parallel Port Connector (14)

Connector type: 2.0mm pitch 2x10 pin header

Pin	Description	Pin	Description
1	STROBE	2	AFD
3	PTD0	4	ERROR
5	PTD1	6	INIT
7	PTD2	8	SLIN
9	PTD3	10	GND
11	PTD4	12	GND
13	PTD5	14	GND (Key)
15	PTD6	16	BUSY
17	PTD7	18	PE
19	ACK	20	SELECT

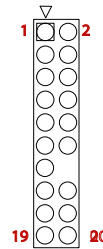

### CON1: RS-422/ 485 Output Connector (15)

Connector type: 2.0mm pitch 1x4 pins wafer connector

Pin	RS-422	RS-485
1	TX+	Data+
2	TX-	Data-
3	RX+	N/C
4	RX-	N/C

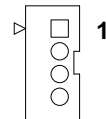

### LCD1: TTL LCD Connector (16)

Connector type: DF-13-40DP-1.25V

Pin	Description	Pin	Description
2	5V_SAFE	1	5V_SAFE
4	GND	3	GND
6	3V_SAFE	5	3V_SAFE
8	GND	7	N/C
10	PD1	9	PD0
12	PD3	11	PD2
14	PD5	13	PD4
16	PD7	15	PD6
18	PD9	17	PD8
20	PD11	19	PD10
22	PD13	21	PD12
24	PD15	23	PD14
26	PD17	25	PD16
28	PD19	27	PD18
30	PD21	29	PD20
32	PD23	31	PD22
34	GND	33	GND
36	VS	35	SHIFT CLOCK
38	HS	37	DE
40	ENAVDD	39	ENABLK

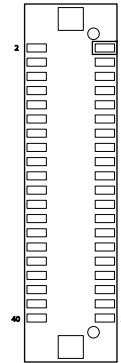

### COM1/ COM2: Serial Port Connector (17), (18)

Pin	Description	Pin	Description
1	DCD	2	RXD
3	TXD	4	DTR
5	GND	6	DSR
7	RTS	8	CTS
9	RI	10	N/C

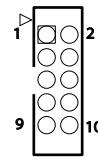

Connector type: 2.0mm pitch 2x5 box pin header

### CFD1: CompactFlash II Socket

CFD1 does not support hot swap.  
Defaulted by first IDE Slave.

Pin	Description	Pin	Description
1	PDD3	26	GND
2	PDD4	27	PDD11
3	PDD5	28	PDD12
4	PDD6	29	PDD13
5	PDD7	30	PDD14
6	CS#0	31	PDD15
7	GND	32	CS#1
8	GND	33	GND
9	GND	34	PDIOR#
10	GND	35	PDIOW#
11	GND	36	+5V
12	GND	37	IRQ14
13	+5V	38	+5V
14	GND	39	CSEL#
15	GND	40	N/C
16	GND	41	IDE_RST#
17	GND	42	PDRDY
18	PDA2	43	PDREQ
19	PDA1	44	PDACK#
20	PDA0	45	IDE_ACT#
21	PDD0	46	CFDIAG
22	PDD1	47	PDD8
23	PDD2	48	PDD9
24	CF_ICS16#	49	PDD10
25	GND	50	GND

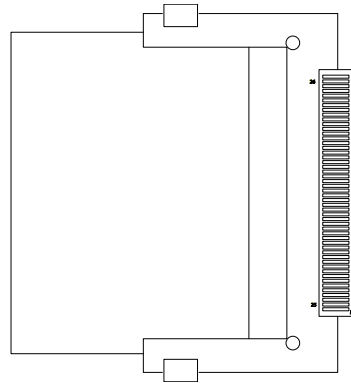

### 2.3 The Installation Paths of CD Driver

Driver	Path
CHIPSET	\Chiset\AMD\LX
ISA	\ISA\ITE8888
LAN	\Ethernet\REALTEK\8100C
VGA	\Graphics\AMD\LX

# Chapter 3

## BIOS

### 3.1 BIOS Introduction

The Award BIOS (Basic Input/Output System) installed in your computer system's. The BIOS provides for a standard device such as disk drives, serial ports and parallel ports. It also adds password protection as well as special support for detailed fine-tuning of the chipset controlling the entire system.

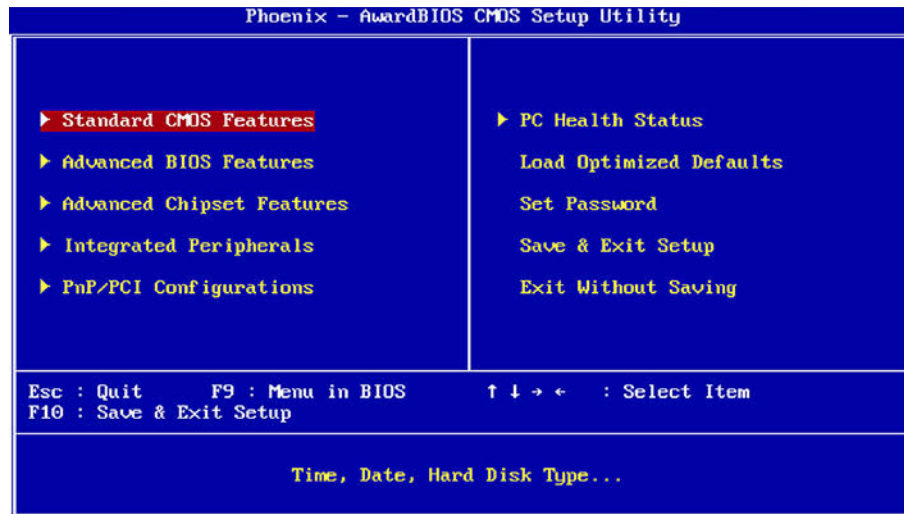

### 3.2 BIOS Setup

The Award BIOS provides a Setup utility program for specifying the system configurations and settings. The BIOS ROM of the system stores the Setup utility.

When you turn on the computer, the Award BIOS is immediately activated. Pressing the <Del> key immediately allows you to enter the Setup utility. If you a little bit late press the <Del> key, POST (Power On Self Test) will continue with its test routines, thus preventing you from invoking the Setup. If you still wish to enter Setup, restart the system by pressing the "Reset" button or simultaneously pressing the <Ctrl>, <Alt> and <Delete> keys. You can also restart by turning the system Off and back On again.

The following message will appear on the screen:

#### Press <DEL> to Enter Setup

In general, you press the arrow keys to highlight items, <Enter> to select, the <PgUp> and <PgDn> keys to change entries, <F1> for help and <Esc> to quit. When you enter the Setup utility, the Main Menu screen will appear on the screen. The Main Menu allows you to select from various setup functions and exit choices.

### 3.3 Standard CMOS Features

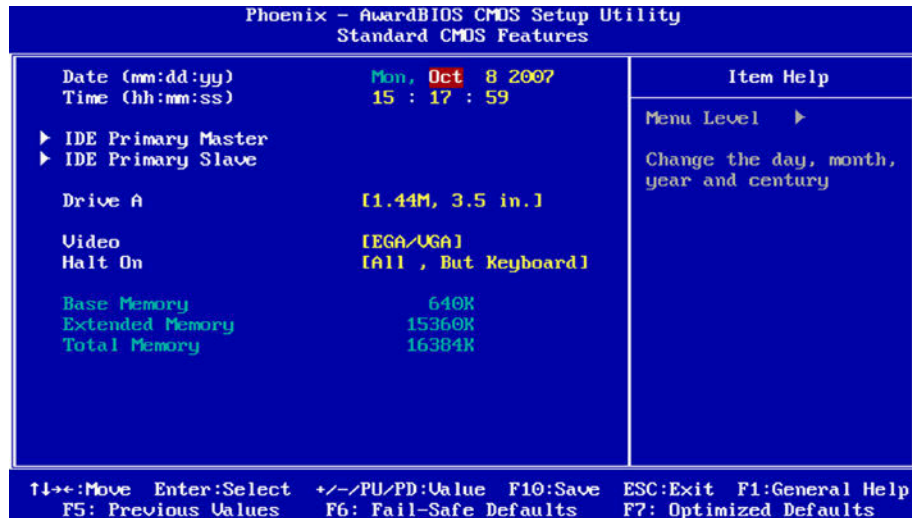

“Standard CMOS Features” allows you to record some basic hardware configurations in your computer system and set the system clock and error handling. If the CPU card is already installed in a working system, you will not need to select this option.

You will need to run the Standard CMOS option, however, if you change your system hardware configurations, such as onboard battery fails, or the configuration stored in the CMOS memory was lost or damaged.

#### Date

The date format is:

- Day** : Sun to Sat
- Month** : 1 to 12
- Date** : 1 to 31
- Year** : 1999 to 2099

#### Time

The time format is:

- Hour** : 00 to 23
- Minute** : 00 to 59
- Second** : 00 to 59

To set the date & time, highlight the “Date” & “Time” and use the <PgUp>/<PgDn> or +/- keys to set the current time.

## IDE Primary HDDs / IDE Secondary HDDs

The onboard PCI IDE connectors provide Primary and Secondary channels for connecting up to four IDE hard disks or other IDE devices.

Each channel can support up to two hard disks; the first is the “Master” and the second is the “Slave”.

Press <Enter> to configure the hard disk. The selections include Auto, Manual, and None. Select ‘Manual’ to define the drive information manually. You will be asked to enter the following items.

Cylinder:	Number of cylinders
Head:	Number of read/write heads
Precomp:	Write precompensation
Landing Zone:	Landing zone
Sector:	Number of sectors

The Access Mode selections are as follows:

CHS	(HD < 528MB)
LBA	(HD > 528MB and supports Logical Block Addressing)
Large	(for MS-DOS only)
Auto	

## Drive A / Drive B

These fields identify the types of floppy disk drive A or drive B that has been installed in the computer. The available specifications are:

None	360K, 5.25 in.	1.2M, 5.25 in.
720K, 3.5 in.	1.44M, 3.5 in.	2.88M, 3.5 in.

## Video

This field selects the type of video display card installed in your system.

You can choose the following video display cards:

EGA/VGA	For EGA, VGA, SEGA, SVGA or PGA monitor adapters. (default)
CGA 40	Power up in 40 column mode.
CGA 80	Power up in 80 column mode.
MONO	For Hercules or MDA adapters.

## BIOS

---

### **Halt On**

This field determines whether or not the system will halt if an error is detected during power up.

All errors (default)	Whenever the BIOS detects a non-fatal error, the system will stop and you will be prompted.
No errors	The system boot will not be halted for any error that may be detected.
All, But Keyboard	The system boot will not be halted for a keyboard error; it will stop for all other errors.
All, But Diskette	The system boot will not be halted for a disk error; it will stop for all other errors.
All, But Disk/Key	The system boot will not be halted for a keyboard or disk error; it will stop for all others.

### 3.4 Advanced BIOS Features

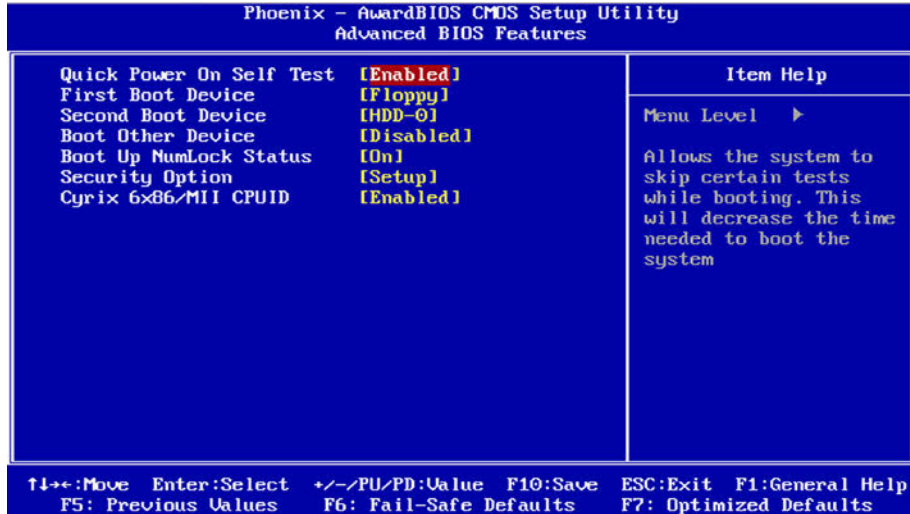

#### Quick Power On Self Test

When enabled, this field speeds up the Power On Self Test (POST) after the system is turned on.

If it is set to Enabled, BIOS will skip some items.

Setting: Enabled (Default), Disabled.

#### First/ Second Boot Device

These fields determine the drive that the system searches first for an operating system. The options available include

Setting: Floppy, LS120, HDD-0, SCSI, CDROM, HDD-1, ZIP100, USB-FDD, USB-ZIP, USB-CDROM, USB-HDD, LAN and Disabled.

#### Boot Other Device

It allows the system to search for an OS from other devices other than the ones selected in the First/ Second/ Third Boot Device.

Setting: Enabled (Default), Disabled.

## BIOS

---

### **Boot Up NumLock Status**

It allows you to activate the NumLock function after you power up the system.

Setting: On (Default), Off.

### **Security Option**

It allows you to limit access to the System and Setup.

When you select System, the system prompts for the User Password every time you boot up.

When you select Setup, the system always boots up and prompts for the Supervisor Password only when the Setup utility is called up.

Setting: Setup (Default), System.

### **Cyrix 6x86/MII CPUID**

Disable CPU ID instruction if you are using Netware v5.0.

Setting: Enabled (Default), Disabled.

### 3.5 Advanced Chipset Features

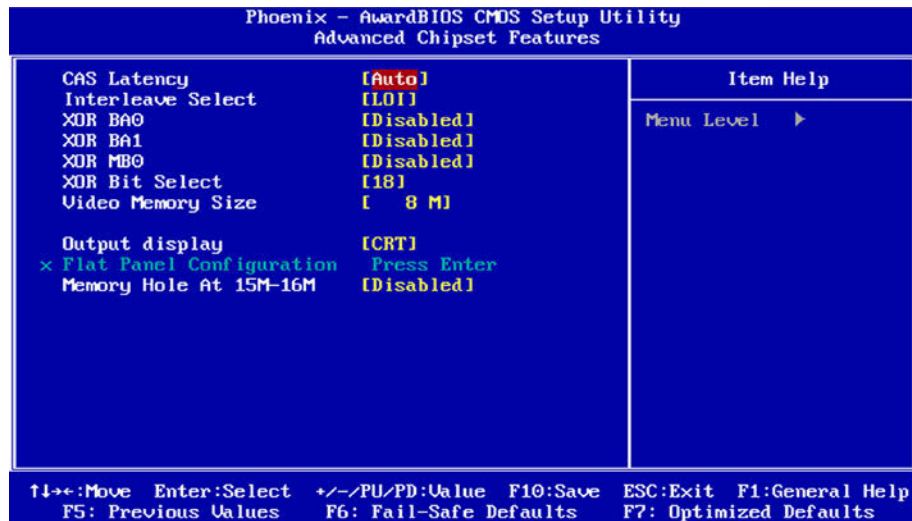

#### CAS Latency Time

It allows CAS latency time in HCLKs as 2 or 2.5. The system board designer should set the values in this field, depending on the DRAM installed. Do not change the values in this field unless you change specifications of the installed DRAM or CPU.  
Setting: 2.5 (Default), 2.

#### Interleave Select

It allows you to Use the Interleave Select option to specify how the cache memory is interleaved.  
Setting: LOI (Default), HOI.

#### XOR BA0

Setting: Disabled (Default), Enabled.

#### XOR BA1

Setting: Disabled (Default), Enabled.

## BIOS

---

### **XOR MB0**

Setting: Disabled (Default), Enabled.

### **XOR Bit Select**

Setting: 18 (Default), 19, 20, 21.

### **Video Memory Size**

In order to determine how much memory is allocated to the video graphics device.

Setting: None, 8M (Default), 16M, 32M, 64M, 128M, 254M.

### **Output display**

In order to specify the display devices the system is connected to.

Setting: Flat Panel, CRT (Default), Panel & CRT.

### **Flat Panel Configuration**

It allows you to open the Flat Panel Configuration menu.

### **Memory Hole At 15M-16M**

In order to improve performance, certain space in memory can be reserved for ISA cards. This memory must be mapped into the memory space below 16 MB.

Setting: Disabled (Default), Enabled.

### 3.6 Integrated Peripherals

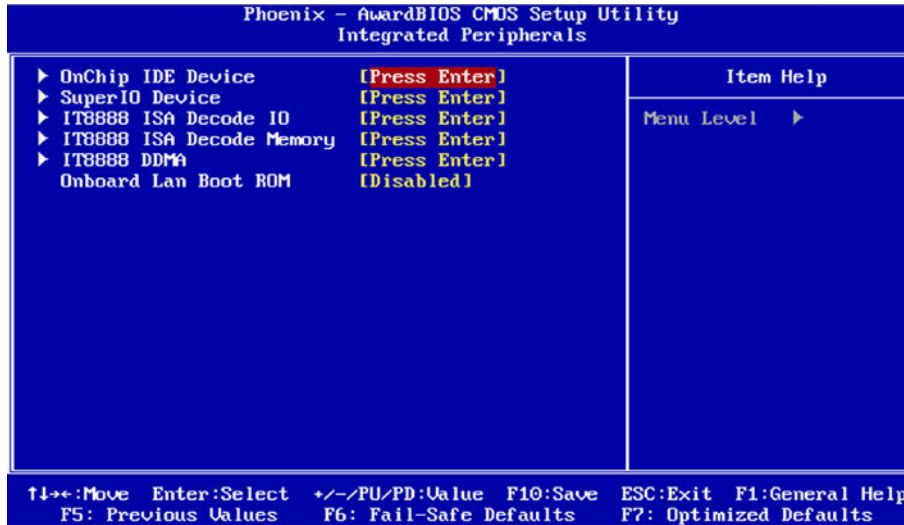

#### OnChip IDE Devicev >>>

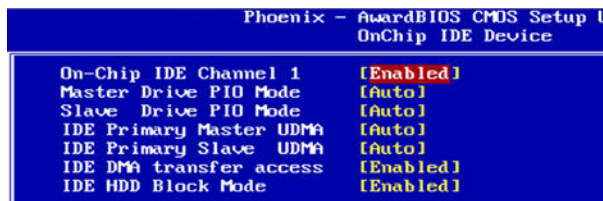

#### On-Chip IDE Channel 1

The integrated peripheral controller contains an IDE interface with support for two IDE channels. Select Enabled to activate each channel separately. Setting: Disabled, Enabled (Default).

### **IDE Primary Master/Slave PIO**

It allows your system HDD controller to run faster.

Rather than having the BIOS issue with a series of commands that transferring to or from the disk drive, PIO (Programmed Input/Output) allows the BIOS to communicate with the controller and CPU directly.

When Auto is selected, the BIOS will select the best available mode.

Setting: Auto (Default), Mode 0, Mode 1, Mode 2, Mode 3, Mode 4.

### **IDE Primary Master/Slave UDMA**

It allows your system to improve disk I/O throughput to 33MB/sec with the Ultra DMA33 feature.

Setting: Disabled, Auto.

### **IDE DMA Transfer Access**

Setting: Disabled, Enabled (Default).

### **IDE HDD Block Mode**

It allows your HDD controller to use the fast block mode to transfer data to and from your HDD drive.

Setting: Disabled, Enabled (Default).

**SuperIO Device >>>**

Phoenix - AwardBIOS CMOS Setup	
SuperIO Device	
Onboard FDC Controller	[Enabled]
Serial Port 1	[3F8/IRQ4]
Serial Port 2	[2F8/IRQ3]
UART Mode Select	[Normal]
RxD , TxD Active	[Hi,Lo]
IR Transmission Delay	[Enabled]
URZ Duplex Mode	[Half]
Use IR Pins	[IR-RxTx2]
Onboard Parallel Port	[378/IRQ7]
Parallel Port Mode	[SPP]
EPP Mode Select	[EPP1.7]
ECP Mode Use DMA	[3]

**Onboard FDC Controller**

Select "Enabled" if you wish to use it. Select "Disabled" if you don't wish to use it.

Setting: Disabled, Enabled (Default).

**Serial/ Onboard Parallel Port**

It allows you to select the onboard serial and parallel ports with their addresses.

Setting:	Serial Port 1	3F8/IRQ4 (Default)
	Serial Port 2	2F8/IRQ3 (Default)
	Parallel Port	378H/IRQ7 (Default)

**UART Mode Select**

It determines the UART 2 mode in your computer.

Setting: IrDA, ASKIR, Normal (Default).

**RxD, TxD Active**

Setting: Hi,Hi , Hi,Lo (Default) , Lo,Hi , Lo,Lo.

**IR Transmission Delay**

Setting: Disabled, Enabled (Default).

## BIOS

---

### **UR2 Duplex Mode**

Setting: Full, Half (Default).

### **Use IR Pins**

Setting: Rx2, Tx2 , IR-Rx2Tx2 (Default).

### **Parallel Port Mode**

Setting:           SPP (Default)  
                  EPP  
                  ECP  
                  ECP+EPP  
                  Normal

### **EPP Mode Select**

Setting: EPP1.9, EPP1.7 (Default)

### **ECP Mode Use DMA**

Setting: 1, 3 (Default).

**IT8888 ISA Decode IO >>>**

```

Phoenix - AwardBIOS CMOS Setup
IT8888 ISA Decode IO

Decode I/O Space 0      [Enabled]
Decode I/O Speed 0     [Slow Speed]
Decode I/O Addr. 0 [15:4] [0A7]
Decode I/O Size 0      [ 16 Bytes]
Decode I/O Space 1     [Enabled]
Decode I/O Speed 1     [Subtractive Speed]
Decode I/O Addr. 1 [15:4] [001]
Decode I/O Size 1      [ 1 Bytes]
Decode I/O Space 2     [Disabled]
× Decode I/O Speed 2     Subtractive Speed
× Decode I/O Addr. 2 [15:4] 001
× Decode I/O Size 2      1 Bytes
Decode I/O Space 3     [Disabled]
× Decode I/O Speed 3     Subtractive Speed
× Decode I/O Addr. 3 [15:4] 001
× Decode I/O Size 3      1 Bytes
Decode I/O Space 4     [Disabled]
× Decode I/O Speed 4     Subtractive Speed
× Decode I/O Addr. 4 [15:4] 001
× Decode I/O Size 4      1 Bytes
Decode I/O Space 5     [Disabled]
× Decode I/O Speed 5     Subtractive Speed
× Decode I/O Addr. 5 [15:4] 001
× Decode I/O Size 5      1 Bytes

```

It allows you to use the IT8888 ISA Decode IO menu to set the IO memory range for the onboard ISA.

**Decode I/O Space 0/ 1/ 2/ 3/ 4/ 5**

It allows you to allocate system resources to the ISA bridge and to enable the function correctly.

Setting: Disabled, Enabled (Default).

**Decode I/O Speed 0/ 1/ 2/ 3/ 4/ 5**

It allows you to specify the speed of the ISA bus.

Setting: Subtractive Speed, Slow Speed, Medium Speed, Fast Speed.

## BIOS

### Decode I/O Address 0/ 1/ 2/ 3/ 4/ 5 [15:4]

It allows you to allocate an address to the ISA bus. The address may range from 0001 to 0FFF.

### Decode I/O Size 0/ 1/ 2/ 3/ 4/ 5

It allows you to specify the size of the ISA bus.

Setting: 1 Byte, 2 Bytes, 4 Bytes, 8 Bytes, 16 Bytes, 32 Bytes, 64 Bytes, 128 Bytes.

### IT8888 ISA Decode Memory >>>

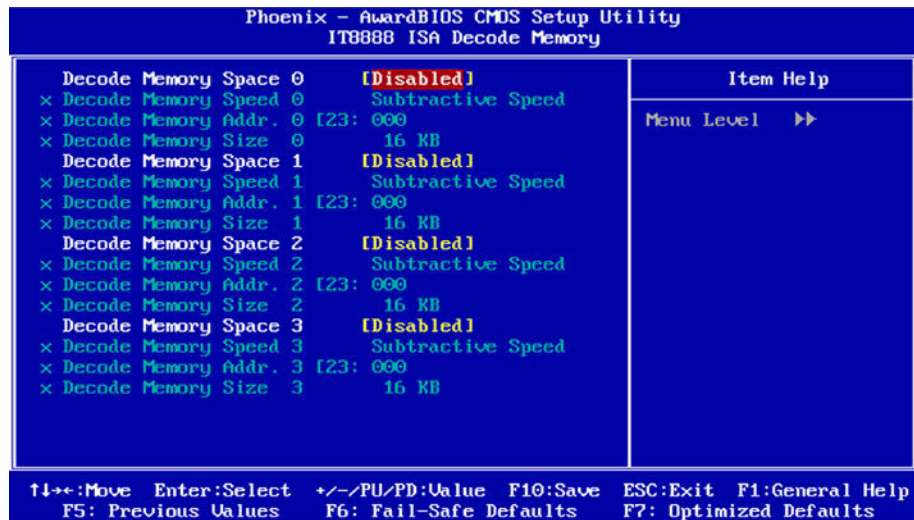

It allows you to use the IT8888 ISA Decode Memory to set the resources for the onboard ISA bus.

### Decode Memory Space 0/ 1/ 2/ 3

It allows you to allocate memory resources to the ISA bridge and to enable the function correctly.

Setting: Disabled (Default), Enabled.

### Decode Memory Speed 0/ 1/ 2/ 3

It allows you to specify the memory speed of the ISA bus.  
Setting: Subtractive Speed, Slow Speed, Medium Speed,  
Fast Speed.

### Decode Memory Addr. 0/ 1/ 2/ 3 [23:

It allows you to allocate a memory address to the ISA bus. The address may range from 0001 to 0FFF.

### Decode Memory Size 0/ 1/ 2/ 3

It allows you to specify the memory size of the ISA bus.  
Setting: 16 KB, 32 KB, 64 KB, 128 KB, 256 KB, 512 KB, 1MB, 2MB.

### IT8888 DDMA >>>

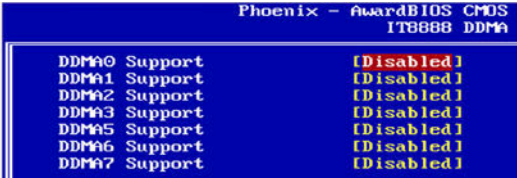

Phoenix - AwardBIOS CMOS Setup Utility		
IT8888 DDMA		
DDMA0 Support		[Disabled]
DDMA1 Support		[Disabled]
DDMA2 Support		[Disabled]
DDMA3 Support		[Disabled]
DDMA5 Support		[Disabled]
DDMA6 Support		[Disabled]
DDMA7 Support		[Disabled]

Suppose that the ISA bus card is required DMA1 & DMA5.  
Set "DDMA1 Support" & "DDMA5 Support" to "Enabled".

### Onboard Lan Boot ROM

Setting: Enabled, Disabled (Default).

### 3.7 PNP/PCI Configurations

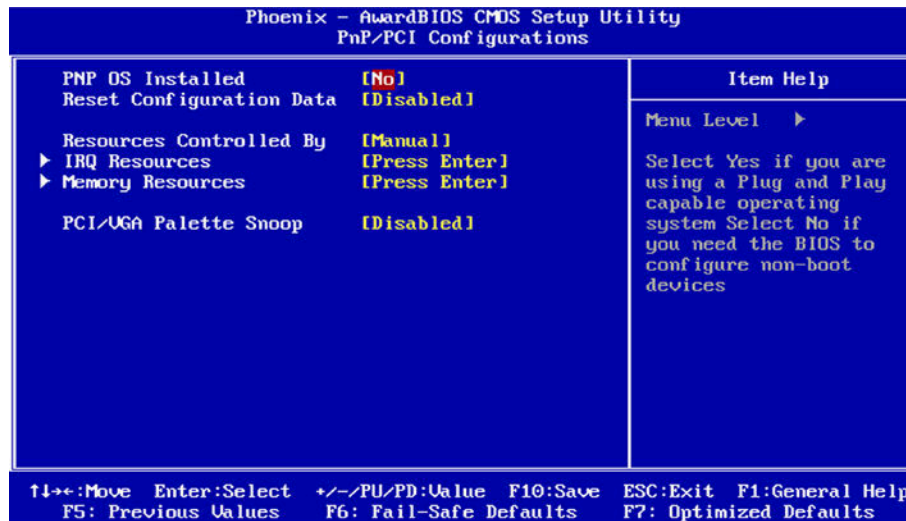

#### PNP OS Installed

It allows you to enable the PNP OS Install option if it is supported by the OS installed.

Setting: No (Default), Yes.

#### Reset Configuration Data

It allows you to determine whether to reset the configuration data or not.

Setting: Disabled (Default), Enabled.

#### Resources Controlled By

This PnP BIOS can configure all of the boot and compatible devices with the use of a PnP operating system.

Setting: Auto(ESCD) (Default), Manual.

### **IRQ Resources**

It allows you to configure the IRQ / DMA Resources.

### **Memory Resources**

It allows you to configure the Memory Resources.

### **PCI/VGA Palette Snoop**

Some non-standard VGA display cards may not show colors properly. It allows you to set whether or not MPEG ISA/VESA VGA cards can display with PCI/VGA.

When "Enabled", a PCI/VGA can display with an MPEG ISA/VESA VGA card.

When "Disabled", a PCI/VGA can not display with an MPEG ISA/VESA VGA card.

Setting: Disabled (Default), Enabled.

### 3.8 PC Health Status

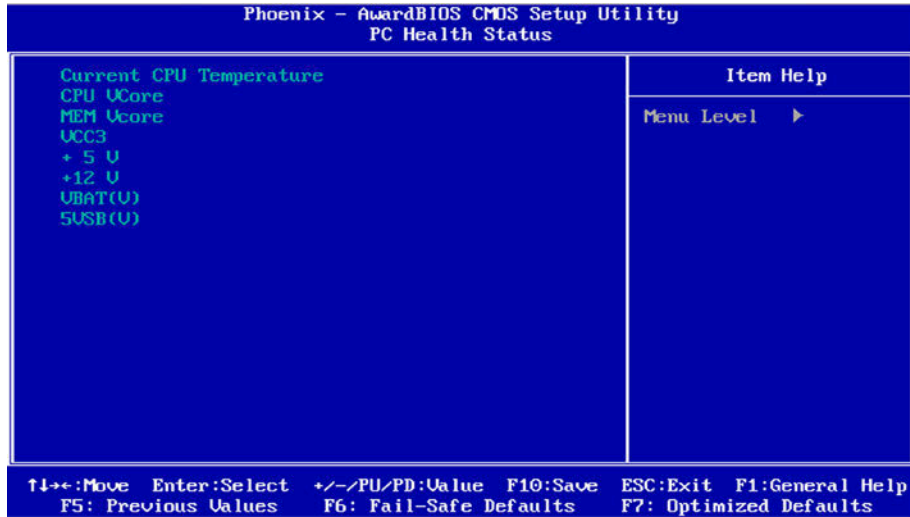

**Current CPU Temperature**

**CPU/ MEM VCore**

**VCC3/ +5V/ +12V/ VBAT(V)/ 5VSB**

### 3.9 Load Optimized Defaults

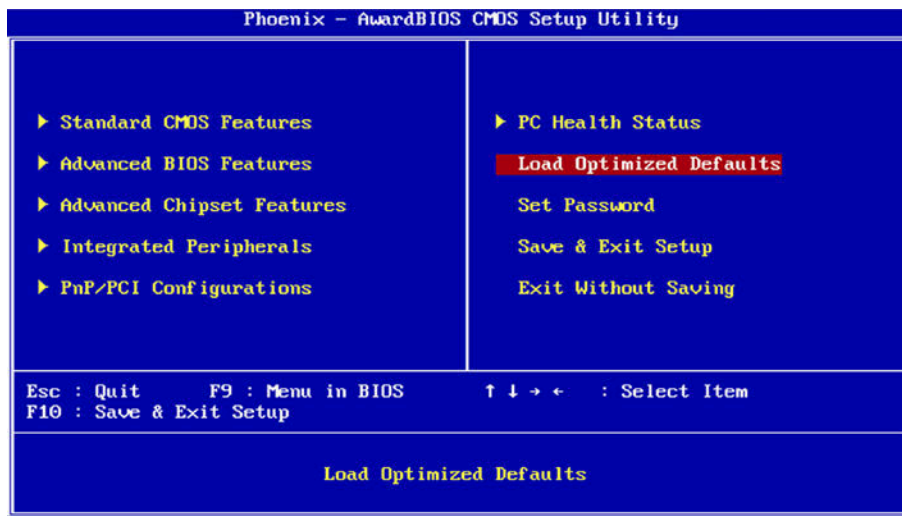

It allows you to load the default values to your system configuration. The default setting is optimal and enabled all high performance features.

### 3.10 Set Password

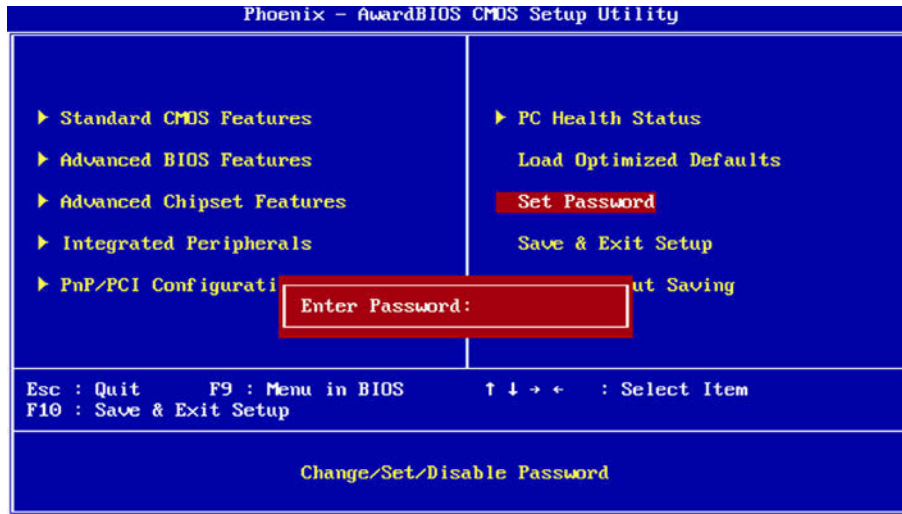

Using Password to set a password that will be used exclusively on the system. To specify a password, highlight the type you want and press <Enter>.

The Enter Password: message prompts on the screen. Type the password, up to eight characters in length, and press <Enter>. And the system confirms your password by asking you to type it again. After setting a password, the screen automatically returns to the main screen.

To disable a password, just press the <Enter> key when you are prompted to enter the password. A message will confirm the password to be disabled. Once the password is disabled, the system will boot, then you can enter BIOS Setup freely.

### 3.11 Save & Exit Setup

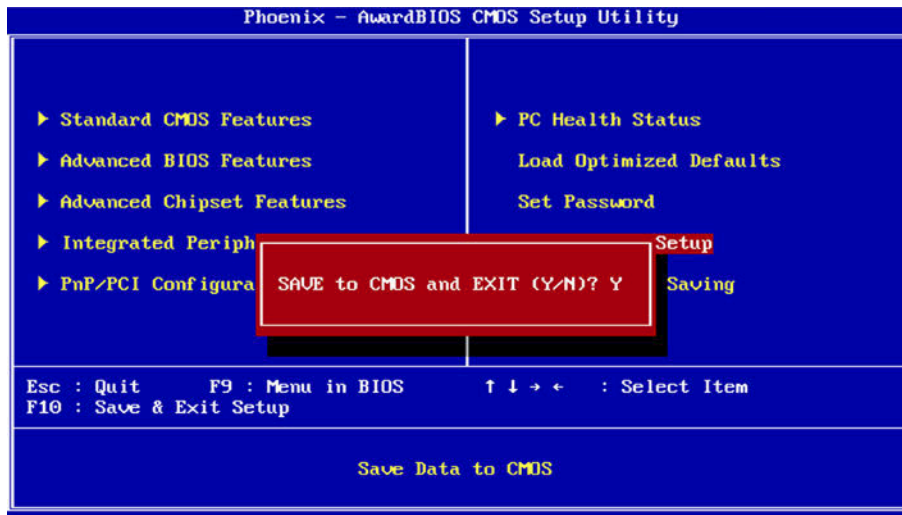

Typing "Y", you will quit the setup utility and save all the changes into the CMOS memory.

Typing "N", you will return to Setup utility.

### 3.12 Exit Without Saving

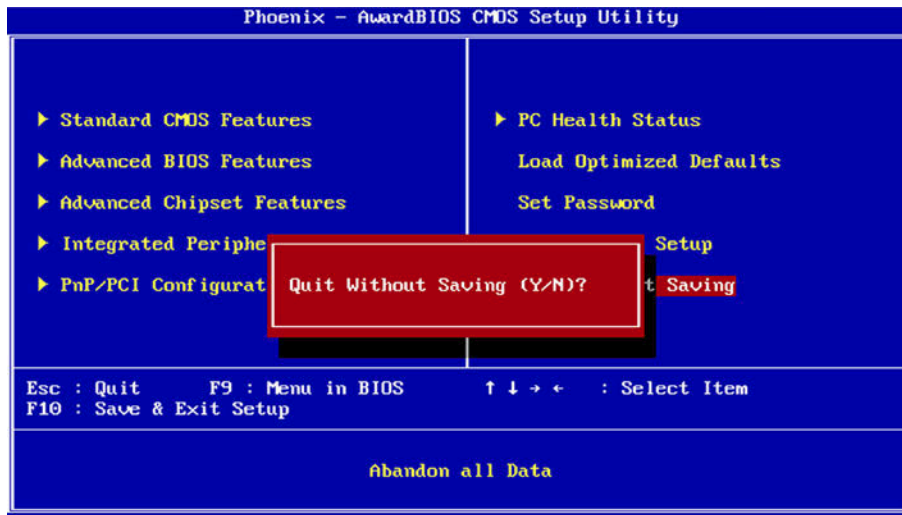

Typing "Y" will quit the Setup utility without saving the modifications.  
Typing "N" will return you to Setup utility.

### 3.13 BIOS Beep Sound code list

Beep Sound	Message
1 short (Beep)	System booting is normally
2 short (Beep)	CMOS setting error
1 long - 1 short (Beep)	DRAM error
1 long - 2 short (Beep)	Display card or monitor connected error
1 long - 3 short (Beep)	Keyboard error
1 long - 9 short (Beep)	ROM error
Long (Beep) continuous	DRAM hasn't inset correctly
Short (Beep) continuous	POWER supply has problem

### 3.14 BIOS memory mapping

Address	Device Description
E000:0000h - F000:FFFFh	System BIOS Area
D000:2000h - D000:FFFFh	Free space
D000:0000h - D000:1FFFh	LAN ROM
C000:E000h - CF00:FFFFh	Free space
C000:0000h - C000:DFFFh	VGA BIOS
A000:0000h - B000:FFFFh	VGA RAM
0000:0000h - 9000:FFFFh	DOS 640K

### 3.15 Award BIOS POST Codes

CFh	Test CMOS read/write functionality
C0h	Early chipset initialization: Disable shadow RAM, L2 cache (socket 7 and below), program basic chipset registers
C1h	Detect memory: Auto detection of DRAM size, type and ECC, auto detection of L2 cache (socket 7 and below)
C3h	Expand compressed BIOS code to DRAM
C5h	Call chipset hook to copy BIOS back to E000 & F000 shadow RAM
01h	Expand the Xgroup codes located in physical memory address 1000:0
02h	Reserved
03h	Initial Superio_Early_Init switch
04h	Reserved
05h	Blank out screen; Clear CMOS error flag
06h	Reserved
07h	Clear 8042 interface; Initialize 8042 self test
08h	Test special keyboard controller for Winbond 977 series Super I/O chips; Enable keyboard interface
09h	Reserved
0Ah	Disable PS/2 mouse interface (optional); Auto detect ports for keyboard & mouse followed by a port & interface swap (optional); Reset keyboard for Winbond 977 series Super I/O chips
0Bh	Reserved
0Ch	Reserved
0Dh	Reserved
0Eh	Test F000h segment shadow to see whether it is read/write capable or not. If test fails, keep beeping the speaker
0Fh	Reserved
10h	Auto detect flash type to load appropriate flash read/write codes into the run time area in F000 for ESCD & DMI support
11h	Reserved
12h	Use walking 1's algorithm to check out interface in CMOS circuitry. Also set real time clock power status and then check for override
13h	Reserved
14h	Program chipset default values into chipset. Chipset default values are MODBINable by OEM customers
15h	Reserved
16h	Initial Early_Init_Onboard_Generator switch
17h	Reserved
18h	Detect CPU information including brand, SMI type (Cyrix or Intel) and CPU level (586 or 686)
19h	Reserved
1Ah	Reserved
1Bh	Initial interrupts vector table. If no special specified, all H/W interrupts are directed to SPURIOUS_INT_HDLR & S/W interrupts to SPURIOUS_soft_HDLR
1Ch	Reserved
1Dh	Initial EARLY_PM_INIT switch
1Eh	Reserved
1Fh	Load keyboard matrix (notebook platform)

20h	Reserved
21h	HPM initialization (notebook platform)
22h	Reserved
23h	Check validity of RTC value; Load CMOS settings into BIOS stack. If CMOS checksum fails, use default value instead; Prepare BIOS resource map for PCI & PnP use. If ESCD is valid, take into consideration of the ESCD's legacy information; Onboard clock generator initialization. Disable respective clock resource to empty PCI & DIMM slots; Early PCI initialization - Enumerate PCI bus number, assign memory & I/O resource, search for a valid VGA device & VGA BIOS, and put it into C000:0
24h	Reserved
25h	Reserved
26h	Reserved
27h	Initialize INT 09 buffer
28h	Reserved
29h	Program CPU internal MTRR (P6 & PII) for 0-640K memory address; Initialize the APIC for Pentium class CPU; Program early chipset according to CMOS setup; Measure CPU speed; Invoke video BIOS
2Ah	Reserved
2Bh	Reserved
2Ch	Reserved
2Dh	Initialize multilanguage; Put information on screen display, including Award title, CPU type, CPU speed, etc...
2Eh	Reserved
2Fh	Reserved
30h	Reserved
31h	Reserved
32h	Reserved
33h	Reset keyboard except Winbond 977 series Super I/O chips
34h	Reserved
35h	Reserved
36h	Reserved
37h	Reserved
38h	Reserved
39h	Reserved
3Ah	Reserved
3Bh	Reserved
3Ch	Test 8254
3Dh	Reserved
3Eh	Test 8259 interrupt mask bits for channel 1
3Fh	Reserved
40h	Test 9259 interrupt mask bits for channel 2
41h	Reserved
42h	Reserved
43h	Test 8259 functionality
44h	Reserved
45h	Reserved
46h	Reserved

## BIOS

---

47h	Initialize EISA slot
48h	Reserved
49h	Calculate total memory by testing the last double last word of each 64K page; Program writes allocation for AMD K5 CPU
4Ah	Reserved
4Bh	Reserved
4Ch	Reserved
4Dh	Reserved
4Eh	Program MTRR of M1 CPU; initialize L2 cache for P6 class CPU & program cacheable range; Initialize the APIC for P6 class CPU; On MP platform, adjust the cacheable range to smaller one in case the cacheable ranges between each CPU are not identical
4Fh	Reserved
50h	Initialize USB
51h	Reserved
52h	Test all memory (clear all extended memory to 0)
53h	Reserved
54h	Reserved
55h	Display number of processors (multi-processor platform)
56h	Reserved
57h	Display PnP logo; Early ISA PnP initialization and assign CSN to every ISA PnP device
58h	Reserved
59h	Initialize the combined Trend Anti-Virus code
5Ah	Reserved
5Bh	Show message for entering AWDFLASH.EXE from FDD (optional feature)
5Ch	Reserved
5Dh	Initialize Init_Onboard_Super_IO switch; Initialize Init_Onboard_AUDIO switch
5Eh	Reserved
5Fh	Reserved
60h	Okay to enter Setup utility
61h	Reserved
62h	Reserved
63h	Reserved
64h	Reserved
65h	Initialize PS/2 mouse
66h	Reserved
67h	Prepare memory size information for function call: INT 15h ax=E820h
68h	Reserved
69h	Turn on L2 cache
6Ah	Reserved
6Bh	Program chipset registers according to items described in Setup & Auto-Configuration table
6Ch	Reserved
6Dh	Assign resources to all ISA PnP devices; Auto assign ports to onboard COM ports if the corresponding item in Setup is set to "AUTO"
6Eh	Reserved
6Fh	Initialize floppy controller; Setup floppy related fields in 40:hardware

70h	Reserved
71h	Reserved
72h	Reserved
73h	Enter AWDFLASH.EXE if: AWDFLASH.EXE is found in floppy drive and ALT+F2 is pressed
74h	Reserved
75h	Detect and install all IDE devices: HDD, LS120, ZIP, CDROM...
76h	Reserved
77h	Detect serial ports and parallel ports
78h	Reserved
79h	Reserved
7Ah	Detect and install coprocessor
7Bh	Reserved
7Ch	Reserved
7Dh	Reserved
7Eh	Reserved
7Fh	Switch back to text mode if full screen logo is supported: if errors occur, report errors & wait for keys, if no errors occur or F1 key is pressed continue - Clear EPA or customization logo
80h	Reserved
81h	Reserved
82h	Call chipset power management hook: Recover the text font used by EPA logo (not for full screen logo), If password is set, ask for password
83h	Save all data in stack back to CMOS
84h	Initialize ISA PnP boot devices
85h	Final USB initialization; NET PC: Build SYSID structure; Switch screen back to text mode; Set up ACPI table at top of memory; Invoke ISA adapter ROM's; Assign IRQ's to PCI devices; Initialize APM; Clear noise of IRQ's
86h	Reserved
87h	Reserved
88h	Reserved
89h	Reserved
90h	Reserved
91h	Reserved
92h	Reserved
93h	Read HDD boot sector information for Trend Anti-Virus code
94h	Enable L2 cache; Program boot up speed; Chipset final initialization; Power management final initialization; Clear screen and display summary table; Program K^ write allocation; Program P6 class write combining
95h	Program daylight saving; Update keyboard LED and typematic rate
96h	Build MP table; Build and update ESCD; Set CMOS century to 20h or 19h; Load CMOS time into DOS timer tick; Build MSIRQ routing table
FFh	Boot attempt (INT 19h)

# Chapter 4

# Appendix

## 4.1 I/O Port Address Map

Each peripheral device in the system is assigned a set of I/O port addresses which also becomes the identity of the device.

The following table lists the I/O port addresses used.

Address	Device Description
00000022 - 0000003F	PCI bus
00000044 - 00000047	PCI bus
0000004C - 0000006F	PCI bus
00000060 - 00000060	PC/AT Enhanced PS/2 Keyboard
00000064 - 00000064	PC/AT Enhanced PS/2 Keyboard
00000072 - 0000007F	PCI bus
00000090 - 00000091	PCI bus
00000093 - 0000009F	PCI bus
000000A2 - 000000BF	PCI bus
000000E0 - 000000EF	PCI bus
00000100 - 00000CF7	PCI bus
00000170 - 00000177	Secondary IDE Channel
000001F0 - 000001F7	Primary IDE Channel
00000274 - 00000277	ISAPNP Read Data Port
00000279 - 00000279	ISAPNP Read Data Port
000002F8 - 000002FF	Communications Port
00000376 - 00000376	Secondary IDE Channel
00000378 - 0000037F	Printer Port
000003B0 - 000003BA	Advanced Micro Devices Win 2K/XP Graphics Driver
000003C0 - 000003DF	Advanced Micro Devices Win 2K/XP Graphics Driver
000003F0 - 000003F5	Standard Floppy Disk Controller
000003F6 - 000003F6	Primary IDE Channel
000003F7 - 000003F7	Standard Floppy Disk Controller

## Appendix

---

000003F8 - 000003FF	Communications Port
00000778 - 0000077B	Printer Port
00000A79 - 00000A79	ISAPNP Read Data Port
00000D00 - 0000FFFF	PCI Bus
0000FC00 - 0000FCFF	Realtek RTL8139/810x family Fast Ethernet NIC
0000FF00 - 0000FF0F	Standard Dual Channel PCI IDE Controller

### 4.2 Interrupt Request Lines (IRQ)

Peripheral devices use interrupt request lines to notify CPU for the service required. The following table shows the IRQ used by the devices on board.

Level	Function
IRQ 01	PC/AT Enhanced PS/2 Keyboard
IRQ 03	Communications Port
IRQ 04	Communications Port
IRQ 05	Standard Enhanced PCI to USB Host Controller
IRQ 05	Standard Open HCD USB Host Controller
IRQ 06	Standard Floppy Disk Controller
IRQ 10	Advanced Micro Devices Win 2K/Win Graphics Driver
IRQ 10	Geode LX AES Crypto Driver
IRQ 11	Realtek RTL8139/810x Family Fast Ethernet NIC
IRQ 12	Microsoft PS/2 Mouse
IRQ 14	Primary IDE Channel

### 4.3 DMA Map

DMA Channel	Device Description
02	Standard Floppy Disk Controller

#### 4.4 Memory Address Map

Address	Device Description
EE000000 - EFFFFFFF	Standard Floppy Disk Controller
EFFE8000 - EFEBFFFF	AMD Win 2K/XP Graphics Driver
EFFEC000 - EFFFFFFF	AMD Win 2K/XP Graphics Driver
EFFF0000 - EFFF3FFF	AMD Win 2K/XP Graphics Driver
EFFF4000 - EFFF7FFF	Geode LX AES Crypto Driver
EFFF8000 - EFFFBFFF	AMD Win 2K/XP Graphics Driver
EFFFD000 - EFFFDFDF	Standard Enhanced PCI to USB Host Controller
EFFFE000 - EFFFFEFFFF	Standard OpenHCD USB Host Controller
EFFFF000 - EFFFF0FFF	Realtek RTL8139/810x Family Fast Ethernet NIC
EFFFF000 - 0009EFFF	PCI Bus
000A0000 - 000BFFFF	PCI Bus
000A0000 - 000BFFFF	AMD Win 2K/XP Graphics Driver
000C8000 - 000EEFFF	PCI Bus
0F7C0000 - FFFEFFFF	PCI Bus